

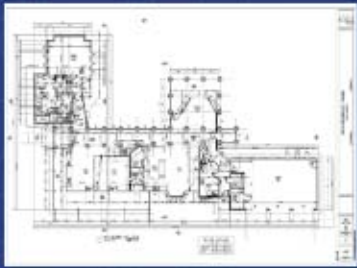

site plans



floor plans



elevations

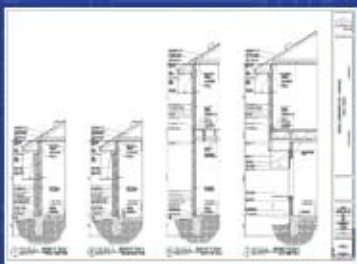

details

Professional CAD System

> ARCHITECTS

> BUILDERS

> RESIDENTIAL DESIGNERS



3D models



Complete System **Only \$995**

Professional CAD System

High Productivity Solution for Architects, Designers and Builders

BuildersCAD is designed and developed architects and builders with real-world experience. It is the most focused and comprehensive CAD solution available today for designing and building residential and light commercial construction projects. It is powerful and flexible, helping you to work smarter and faster with greater accuracy and efficiency. Stop wasting time and start saving effort and money.

COMPLETE SOLUTION

BuildersCAD has everything you need to design and produce professional construction documentation for any size project. It provides a full arsenal of intelligent, design automation tools that greatly reduce the repetitive tasks associated with production drawing. It can accelerate and simplify your work process. It solves real problems with simple and intelligent solutions. Streamline your design and production process with BuildersCAD.

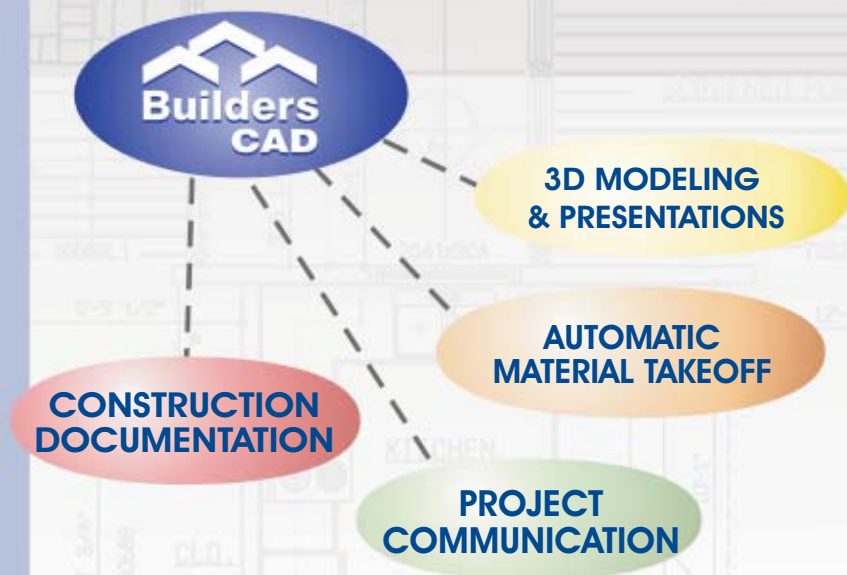



Simpler, Smarter, Faster and Better

- ✓ Reduce Design and Drafting Time
- ✓ Communicate Faster and Better
- ✓ Easily Make Plan Changes
- ✓ Make Quick, Effective Presentations
- ✓ Developed by Architects and Builders

Lower Cost, Better Performance



The best tools for the job!

A Complete Solution!

CONSTRUCTION DOCUMENTATION

Automate your construction documentation process with focused, high productivity tools.

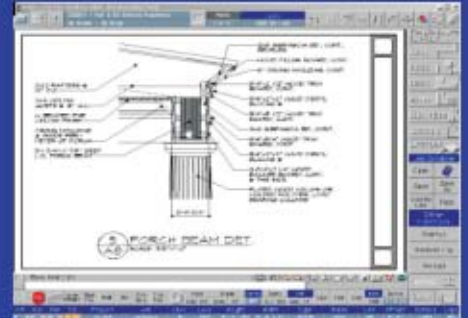

3D MODELS AND PRESENTATIONS

Show simple and complex 3D model designs to customers for presentations.

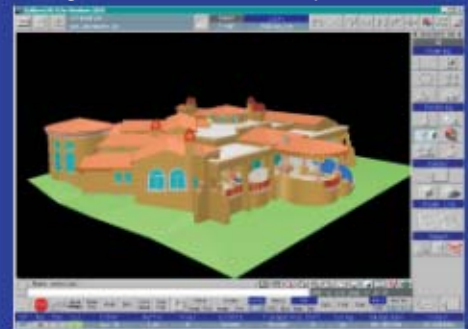

'LIVE' TEAM COLLABORATION

Solve problems faster with real-time communication between team members.

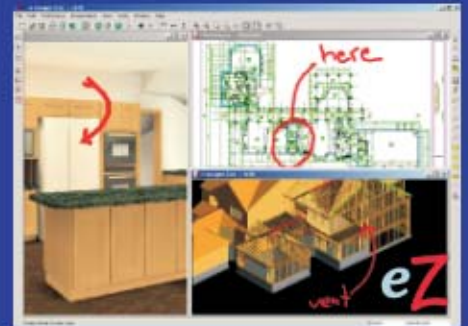

MATERIALS TAKEOFF

Takeoff materials directly from CAD drawings and 3D models.



CONSTRUCTION DOCUMENTATION

Save time with automatic construction documentation.

BuildersCAD automates, streamlines and organizes your entire construction documentation process. You have at your disposal an arsenal of intelligently designed CAD tools created by licensed architects and builders to solve real world productivity problems.

- > Draw intelligent walls, not just lines.
- > Generate roofs automatically
- > Create elevations from wall, roof and floor data
- > Create sections from wall, roof and floor data
- > Choose from 5000+ pre-drawn catalog objects
- > Customize symbol libraries
- > Generate materials lists for placed symbols
- > Place dimensions with a simple mouse click
- > Copy parameters from one design to another

Floor Plans with raster images



Site Plans with raster image backgrounds



Organized for High Productivity

5000+ CATALOG ITEMS

Select from over 5000 items with the click of a button. Thumbnail images of the items help you to spend less time searching for what you need.

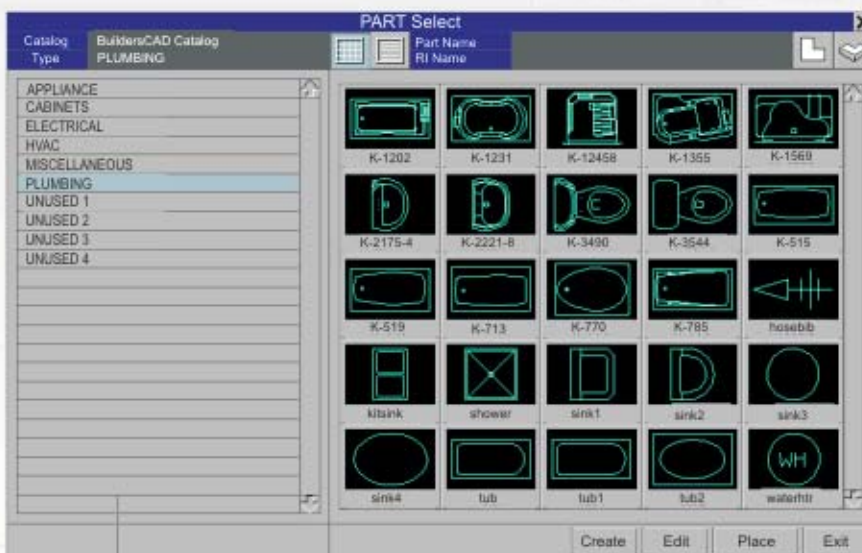

BuildersCAD helps you organize all the various symbols, items, details, and repeated objects that you use in your drawings and models.

- Windows
- Doors
- Plumbing Fixtures
- Appliances
- Electrical Fixtures
- HVAC
- Cabinets
- Landscape
- Cars

- ✓ 2D / 3D Viewports
- ✓ Automatic Room Labeling
- ✓ Automatic Layer Management
- ✓ Integrated Redline & Markup
- ✓ Notes Wizard

CONSTRUCTION DRAWING FEATURES:

- Full array of 2D and 3D CAD tools
- Smart Graphics: Walls, Doors, Windows, Fixtures, Appliances, Plumbing, Electrical, etc.
- Automatic Door and Window Schedules
- Automatic Elevations
- Automatic Sections
- Automatic Dimensions
- Save and catalogue notes
- Automatic 3D
- Dynamic 3D Viewing
- Export takeoff data to spreadsheet and accounting software
- Fully customizable
- Direct export into eZ for fast project conferencing

FLOOR PLANS

Any changes made to your plans will automatically appear on your layout sheets.

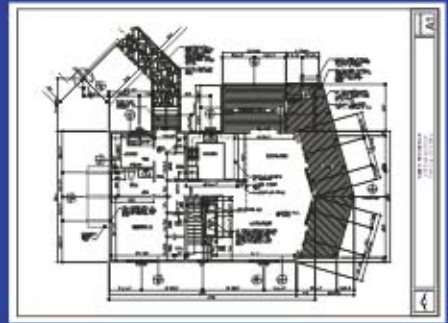

ELEVATIONS

Create detailed elevations from your plans.



CROSS-SECTIONS

Create accurate and detailed cross sections.



DETAILS

Store details in easy to use catalog libraries for fast placement in drawings.

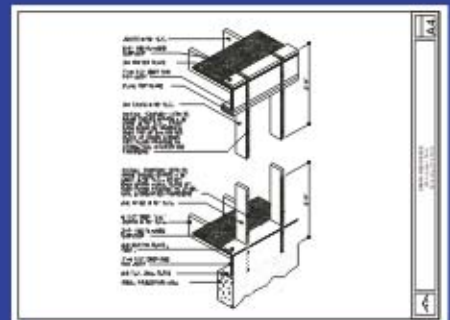

3D MODELING & VISUALIZATION

Easily generate 3D models before building begins.

BuildersCAD 3D includes all the tools needed to create both simple and complex 3D architectural designs. Models can be quickly constructed and viewed from any vantage point with a simple click of a mouse. Easy to use tools help you build models and 3D geometry with automated parametric routines for walls, doors, windows, roofs, fixtures, furniture, and more.

Stop at any point while drawing walls and quickly generate a 3D model of your design. Dynamically view and cut sections through your 3D design. Combine multiple 3D models and 2D project drawings into one simple to create presentation.

- > Zoom, pan and rotate to explore from every angle
- > Easily place raster images in model views
- > True Color Display and Shadowing
- > Excellent 3D Roof Generator for complex roofs
- > Quickly create dormers with the 3D Dormer wizard

3D Model Rear View



3D Model Front View



Work Smarter and Faster

SketchUp @Last SOFTWARE

SketchUp combines a compact yet robust tool-set with an intelligent guidance system that streamlines the 3D drawing process. The result is an interface that supports a dynamic, creative exploration of 3D form, material and light without requiring large investments in training and support.

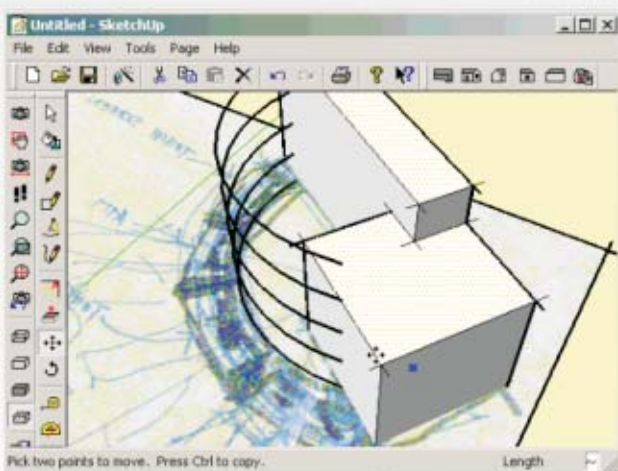

- > Simple & Fast
- > Patent Pending Push/Pull Tool
- > "Sketchy" Rendering
- > Accurate Realtime Shadows
- > Material Exploration
- > Presentation Animations
- > Interactive Sections
- > Versatile Component Architecture
- > Dimensions and Annotation
- > Imports and Exports (Import DWG/DXF) (Exports DWG, DXF, 3DS, VRML, PDF, EPS, JPG, TIF, PNG, etc.)

SPECIAL OFFER!

BuildersCAD / Sketchup Bundle

Only
\$1295

New Feature!



Place a raster background in your 3D model.

Professional 3D Modeling

3D MODELING FEATURES:

- Over 5000+ pre-created 3D model repeated items
- Easily assemble custom 3D libraries
- 3D model develops automatically as you enter the plan
- Easy-to-use roof generator for complex roofs
- 3D Dormer Wizard
- 3D Stair Wizard
- Direct link to eZ for dynamic viewing and sectioning
- Direct link to eZ for building presentations
- Easy-to-use perspective viewing application
- Automatic creation of hidden-line removal drawings
- Place multiple lights and light sources
- Shadow studies based on location and time of day
- Easily create and record animation frames

Easy-to-use 3D Tools!

DYNAMIC VIEWING

Zoom, pan and rotate to explore from every angle.



DYNAMIC SECTIONING

Slice through your 3D model with dynamic sectioning tools.



3D DORMER WIZARD

Quickly create and tie dormers into the main roof with the click of a button.

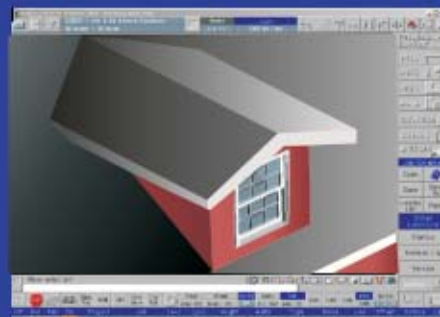

3D STAIR WIZARD

Specify the floor-to-floor dimension, number of risers and length of the treads and BuildersCAD creates the stairs for you.



'LIVE' TEAM COLLABORATION

Simple, convenient, interactive project communication

Every new seat license purchase of BuildersCAD includes a one-year subscription to eZ — a \$399 stand alone value. eZ allows you to collaborate in real-time with BuildersCAD drawings, 3D models, digital photos, MS Office documents and all project information. Connect 'Live' to job sites, consultants, and customers with ease and simplicity.

The combination of eZ within the BuildersCAD solution provides the industry's highest performance integrated system for collaboration on any type of design or construction project. Your team gets the job done with greater accuracy, speed and quality.

- > Sketch and markup simultaneously
- > Share different types of files in the same conference
- > View DWG and DXF files without other costly applications
- > Participate in multi-location conferences
- > Easily save meeting notes and sketches

Build Better Teams and Stronger Relationships

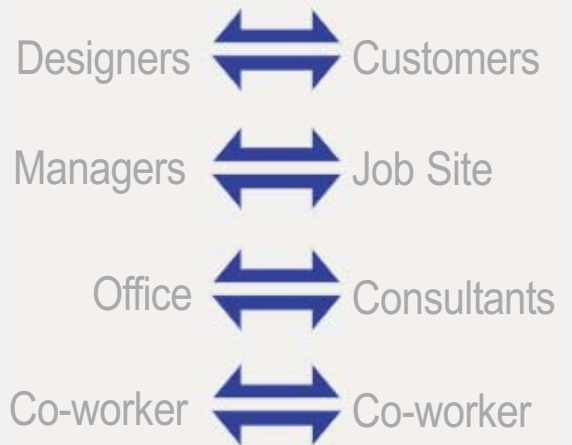

Fast, effective team communication.

PROJECT ORGANIZATION

BuildersCAD's catalog system allows you to group project information for easy access. Projects may be grouped by type, location or any method you choose. Descriptive names as well as project numbers, and thumbnail graphics make it simple to find project files.



Quickly locate and access all of your drawings.

eZ 'Live' Team Collaboration

From the office, from the road or from the field.



Solve problems quickly!

1-Year FREE eZ subscription

(\$399 Value- FREE with BuildersCAD new seat purchase)

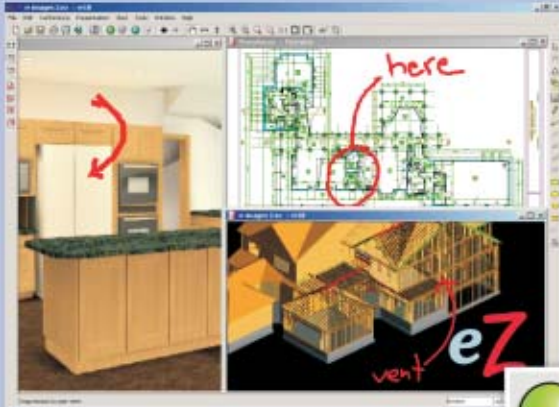

- Conduct Virtual Presentations
- Markup and Collaborate 'Live'
- Dynamically View 3D Models
- Save Time and Money
- Enhance Relationships
- Respond to Problems Quickly



eZ Features

REDLINE & MARKUP

Review and communicate changes with easy-to-use drawing and text tools.

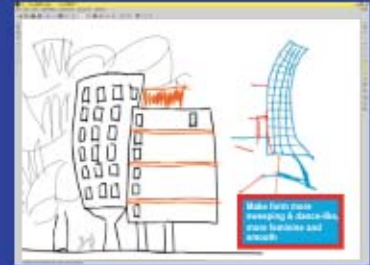

UNIVERSAL VIEWER

View and share different file types in one application without other costly programs.

CAD Drawing

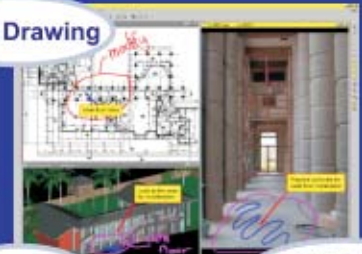

3D Model

Digital Photo

MULTI-LOCATION CONFERENCING

Collaborate on any subject regardless of where the people or information is located.



QUICK AND SIMPLE PRESENTATIONS

Quickly combine and mix different file types into one simple eZ presentation.

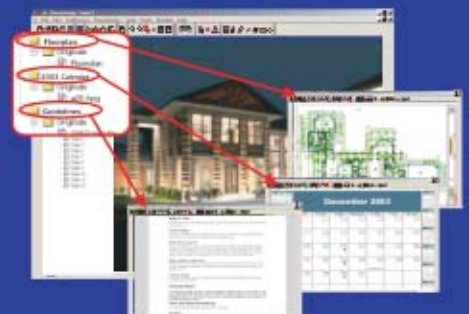

AUTOMATIC MATERIALS TAKEOFF

Increase your productivity and save valuable time.

Using the plan you've drawn, BuildersCAD's Materials Application can run a report on the materials and parts from actual counts and customizable estimating formulas. You can apply a formula to a house or any part of a house and BuildersCAD will include a list of materials for that specific portion of the job. Export these reports into any external editor such as Notepad or Word. Integrated materials takeoffs can increase your productivity, and save you valuable time and money.

- > Soft Costs (utilities, loan interest, etc)
- > Site Costs (grading, fill dirt and landscaping)
- > Foundation Materials (slab, block and rebar)
- > Windows and Doors (interior and exterior)
- > Electric, HVAC and Plumbing
- > Interior Finish Materials (dry wall, trim, floor and labor)
- > Cabinets (kitchen, vanities and counter tops)

Automatically generate a schedule of materials.

LEVEL	ALL	ITEM#	DESCRIPTION	QTY PURCHASED
PACKAGE		060355	BASE MOLD	424 LFT
Subpackage (TOOTH) total: 0.00				
Package (3200) total: 0.00				
ROOFING		061116	2X8X10 #3 STP	19 KA
ROOFING		061122	2X8X10 #3 STP	47 KA
ROOFING		061124	2X8X14 #3 STP	40 KA
ROOFING		061128	2X8X10 #3 STP	3 KA
ROOFING		061131	2X8X14 #3 STP	4 KA
ROOFING		061137	2X8X12 COM. FINISH PINE	11 KA
ROOFING		061138	2X8X14 COM. FINISH PINE	11 KA
Subpackage (ROOF - LEVEL A) total: 0.00				
ROOFING		060378	1/2"X4X8 CDR PLYWOOD	3 SHEET
ROOFING		060382	1/2"X4X8 PGR INTRU BOARD	24 SHEET
ROOFING		060388	2X8X10 #3 STP	11 KA
ROOFING		061201	2X8X10 SPF	48 KA
ROOFING		061203	2X8X12 SPF	4 KA
ROOFING		061207	2X8X10 SPF	3 KA
ROOFING		061221	2X8X14 SPF	11 KA
ROOFING		061228	2X8X12 STD 2ND STP	48 KA
ROOFING		061229	2X8X12 5/8" PRE-CUT STD 2ND STP	238 KA
ROOFING		061238	2X8X12 5/8" PRE-CUT STD 2ND STP	7 KA
ROOFING		060912	1/2"X4X8 INTWALL	90 SHEET
Subpackage (WALLS - LEVEL A) total: 0.00				
ROOFING		060378	1/2"X4X8 CDR PLYWOOD	3 SHEET
ROOFING		060382	1/2"X4X8 PGR INTRU BOARD	9 SHEET
ROOFING		060388	2X8X10 #3 STP	10 KA
ROOFING		061201	2X8X10 SPF	51 KA
ROOFING		061203	2X8X12 SPF	4 KA
ROOFING		061207	2X8X10 SPF	3 KA
ROOFING		061221	2X8X14 SPF	19 KA
ROOFING		061222	2X8X10 STD 2ND STP	10 KA
ROOFING		061224	2X8X12 STD 2ND STP	4 KA
ROOFING		061228	2X8X12 STD 2ND STP	181 KA
ROOFING		061229	2X8X12 5/8" PRE-CUT STD 2ND STP	104 KA
ROOFING		061237	2X8X12 STD 2ND STP	5 KA
ROOFING		060912	1/2"X4X8 INTWALL	90 SHEET
Subpackage (WALLS - LEVEL B) total: 0.00				
Package (ROOFING) total: 0.00				
Total cost: 0.00				

Automate your takeoff & estimation

AUTOMATIC MATERIALS TAKEOFF

With BuildersCAD you can run materials reports and quantity reports with the click of a button. You can quickly and easily export your reports for editing.

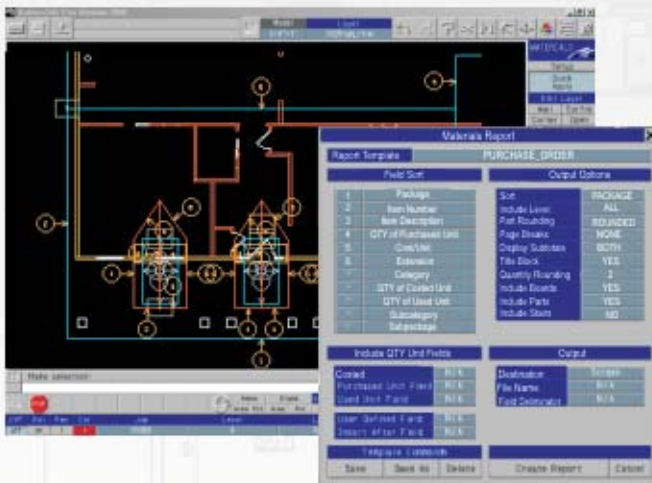

MATERIALS TAKEOFF

- Materials Reports
- Quantity Reports



Generate takeoffs in a fraction of the time!

Quick & Easy to Export

PRICING



Complete System

New Seat

Only
\$995

BuildersCAD 8.1 Includes:

1-Year Maintenance Subscription



Designer

Contains architectural design and drafting tools.



Site Design

Parametric tools for the layout and design of site plans.



Materials

Run materials reports and quantity reports.



PDF Wizard

Create PDFs directly from BuildersCAD.



3D Modeling

Quickly and easily create 3D models.



'Live' Communication

1-Year Subscription to eZ



BuildersCAD / SketchUp Bundle

Combine the best CAD solution with the best 3D sketching solution at a special price.

Only
\$1295

Intelli-Framer

(Includes BuildersCAD)

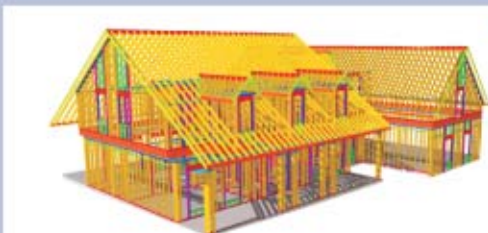

Only
\$2995

Take your productivity to the next level with Intelli-Framer.

- Automatic Panel Drawings
- Optimized Framing Cut Lists
- 3D Wall, Roof & Floor Framing
- Automated Framing Layouts

*Wood Framing —
Solved!*

What's New in BuildersCAD 8.1

BuildersCAD 8.1 offers new and enhanced functionality that enables you to create drawings with speed, ease, and efficiency.

- ✓ TRUE-COLOR RENDERING
- ✓ RASTER IMAGE SUPPORT
- ✓ SCALED RASTER BACKGROUND
- ✓ SITE AND 3D PLUGINS
- ✓ PDF WIZARD
- ✓ R I LIBRARY MANAGER
- ✓ MS BROWSER WINDOW
- ✓ 1 YEAR MAINTENANCE

Upgrade Now!

8.1 Maintenance Subscription

The BuildersCAD Version 8.1 Maintenance Subscription includes the current version upgrade plus additional upgrades for a full year after purchase.

From BuildersCAD 8.0 — **\$500**

From BuildersCAD 2001 — **\$695**

8.1 Fixed-Seat Upgrade

From BuildersCAD 8.0 — **\$695**

From BuildersCAD 2001 — **\$795**

To order call 1.888.990.0900
or visit us online at
www.BuildersCAD.com

Drawings

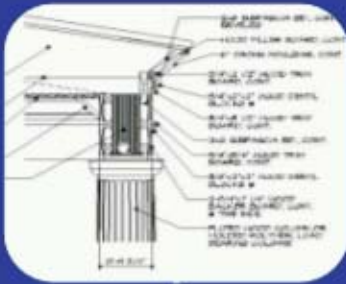

Models



'Live' Meetings



Takeoffs



GET MORE FOR YOUR MONEY!

BuildersCAD is a complete professional 2D/3D CAD solution that delivers extraordinary value at a low cost. Not only does it cost less, but BuildersCAD gives you productivity tools other systems can't match.

> **CONSTRUCTION DOCUMENTATION**

> **3D MODELING & PRESENTATIONS**

> **eZ 'LIVE' TEAM COLLABORATION**

> **AUTOMATIC MATERIALS TAKEOFF**

Complete System

Only
\$995

1-888-990-0900

www.BuildersCAD.com